



UNIVERSIDAD DISTRITAL  
FRANCISCO JOSÉ DE CALDAS

## Visión Electrónica Más que un estado sólido

<https://doi.org/10.14483/issn.2248-4728>



VISIÓN ELECTRÓNICA

A CASE-STUDY VISION

### Robot vehicle control prototype by EMG signals

#### Prototipo control de vehículo robot por señales EMG

Renso Mardu Molano-Pulido <sup>1</sup>, Félix Parca-Acevedo <sup>2</sup>, Francia María Cabrera <sup>3</sup>, Henry Ñungo-Londoño <sup>4</sup>

#### INFORMACIÓN DEL ARTÍCULO

##### Historia del artículo:

Enviado: 16/03/2021  
Recibido: 12/04/2021  
Aceptado: 01/07/2021

##### Keywords:

Amplification  
EMG signals  
Microcontroller  
Robot vehicle  
Wireless transmission



##### Palabras clave:

Amplificación  
Señales EMG  
Microcontrolador  
Vehículo Robot  
Trasmisión inalámbrica

#### ABSTRACT

The EMG (Electromyography) signals are basically electrical pulses emitted by the nerves and muscles of the extremities of the human body, (for example the biceps of the arm) which are obtained by means of electrodes. These signals can be amplified and used in different activities or jobs. In the present investigation the EMG signals, acquired from the biceps of the arm to be used, are used by means of three surface electrodes specifically placed to be able to acquire the signals transmitted by the biceps muscles, which with the use of a differential amplifier will be measured and amplified the difference in voltage between the three electrodes that is placed in the muscle, taking into account that the signals are between the ranges of  $\mu\text{V}$  and less than  $10\text{mV}$ . In the following stages the preparation of the signal is done to connect it to a microcontroller. In this case, the Arduino card will be used, where the already amplified signal is processed and transmitted wirelessly with the help of NRF24L01, which has a range of 1000 meters away from the control system in the Robot Vehicle. In this comes the variation of tension depending on the deflection of the arm and therefore the Robot vehicle accelerates or slows down depending on the signal emitted by the arm amplifier system. Finally, the prototype is adjusted and the fundamental mechanical-electronic characterizations for the different control movements are established.

#### RESUMEN

Las señales EMG (Electromiografía) son básicamente pulsos eléctricos emitidos por los nervios y músculos de las extremidades del cuerpo humano, (ejemplo el bíceps del brazo) los que se obtienen por medio de electrodos. Estas señales se pueden amplificar y ser utilizadas en diferentes actividades o trabajos. En la presente investigación se utilizan las señales EMG, adquiridas del bíceps del brazo a utilizar, por medio de tres electrodos superficiales colocados específicamente para poder adquirir las señales transmitidas por los músculos del bíceps, que con la utilización de un amplificador diferencial se medirá y amplificará la diferencia de voltaje entre los tres electrodos que se coloca en el músculo, teniendo en cuenta que las señales se encuentran entre los rangos de  $\mu\text{V}$  y menores de  $10\text{mV}$ . En las siguientes etapas se realiza la preparación de la señal para conectarla a un microcontrolador. En este caso se utilizará la tarjeta Arduino, en donde se procesa la señal ya amplificada y se trasmite inalámbricamente con la ayuda del NRF24L01, que tiene un alcance de 1000 metros de distancia al sistema de control que está en el Vehículo Robot. En este llega la variación de tensión dependiendo de la deflexión del brazo y por lo tanto el vehículo Robot se acelera o desacelera dependiendo de la señal emitida por el sistema amplificador del brazo. Finalmente se ajusta el prototipo y se establecen las caracterizaciones fundamentales mecánicas-electrónicas para los diferentes movimientos de control.

<sup>1</sup> Escuela de Suboficiales Fuerza Aérea – ESUFA, Colombia. E-mail: [renso.molano@esufa.edu.co](mailto:renso.molano@esufa.edu.co)

<sup>2</sup> TICS-SAS, Colombia. E-mail: [fpao32485@gmail.com](mailto:fpao32485@gmail.com)

<sup>3</sup> Escuela de Suboficiales Fuerza Aérea – ESUFA, Colombia. E-mail: [francia.cabrera@esufa.edu.co](mailto:francia.cabrera@esufa.edu.co)

<sup>4</sup> Escuela de Suboficiales Fuerza Aérea – ESUFA, Colombia.

## 1. Introduction

This research seeks to encourage the academic community in the study, development and innovation of technologies to be able to create culture in the use of bioelectric signals generated by the muscles of the body.

Given that these signals are difficult to acquire and process because they are very small (in a range of 1-10mV) and highly susceptible to noise. [1,2]

This project focuses on the interaction of bioengineering with a motion control system of a Robot-Vehicle that is located in the Avionics laboratory, belonging to the aeronautical electronics technology of the non-commissioned officer's school "CT Andrés M. Díaz", together with the research group on security, electronics and aeronautical defense technologies (GITSEDA).

The prototype consists of acquiring the electromyographic signals (EMG), which are processed in different stages: amplification, filtration, analog-digital conversion (ADC) and sent wirelessly to the control and generate movement to the robot vehicle.

We can find other research that has been done in the registration and processing of the EMG signals in which we find.

The study entitled Superficial EMG multichannel classification using vector machines as a support and signal optimization, proposes a method for the supervised classification of multichannel surface electromyographic signals in order to control myoelectric prostheses. [3].

In a study published in Intelligent Signal Processing and Communications Systems (ISPACS), Intuitive Robot Navigation through EMG and Wireless Sensor Acceleration in the Human Arm, a new method of controlling robot navigation through electromyography (EMG) and acceleration sensors attached to human arms is proposed. This method allows the user to control the robot remotely by its intuitive movement as the direction of the car. [4-5].

We can appreciate that in Mexico we are also working on the acquisition of EMG signals and transmit them wirelessly to have a database of the person's muscular behavior. [2]

In the article Design of a wireless electromyographic signal acquisition system, this new EMG signal acquisition system can acquire the myoelectric signals produced by the muscles in real time in order to save and graph the data obtained, in this way Muscle activity can be calculated, analyzed and studied. [2]

In recent years, the acquisition and analysis of electromyographic signals in real time has been extremely difficult in one of the research fields with the greatest boom due to its multiple applications. [2-6-7].

One of the most important is the control of exoskeletons as support of the human movement, for example, its use in rehabilitation, prosthesis control and training for the analysis and increase of strength [2-8-9]. As part of the same studies conducted in EMG, different researchers have developed the control of machine-robots, through muscle activation [2-10-11].

## 2. Robot Vehicle Control System

The investigation is developed for the speed control of a robot-vehicle, with the processing of the EMG signals.

Before examining the EMG signals, we must analyze that performing a simple movement requires the intervention and joint work of many neurons. The process is as follows: the order is generated in the brain and transmitted in the form of an electrical impulse, this impulse travels through the spine and reaches the motor neurons responsible for innervating the muscle that develops the action stimulating muscle fibers and thus producing the expansion or muscle inhibition. [12]

**Figure 1.** Process that follows EMG signals [19].

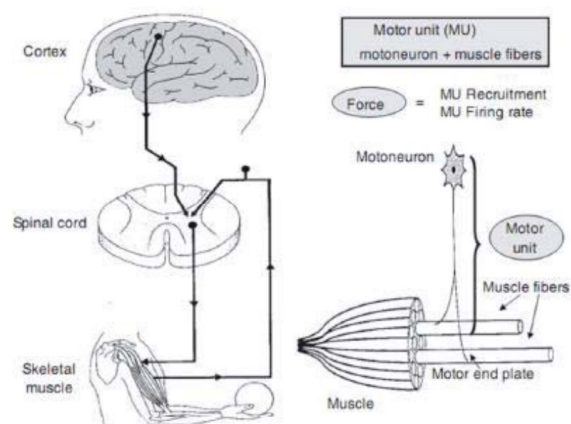

### 2.1. EMG signals

The human body generates different types of electrical potentials or signals such as electroencephalography (EEG), electromyography (EMG), electrooculographic (EOG) and electrocardiographic (ECG) among others,

which provide the functioning of the body's organs. The study of these signals can be used for the detection of pathologies of the organs that produce them. [13]

The different signals generated with different levels and frequencies as seen in table 1.

**Table 1.** The frequency range and dynamic range for various bioelectric signals are shown. [2]

Bioelectric signals	Frequency range	Dynamic range
Electroneurogram (ENG)	100Hz- 1kHz	5 $\mu$ V – 10 mV
Electroretinogram (ERG)	0.2 – 200Hz	0.5 $\mu$ V – 1 mV
Electrooculogram (EOG)	DC – 100Hz	10 $\mu$ V – 5 mV
Electroencephalogram (EEG)	0.5 – 100Hz	2 – 100 $\mu$ V
Electrocorticogram	100Hz – 5kHz	0.5 – 10 $\mu$ V
Electromyography (EMG)	500Hz – 10kHz	1 – 10 $\mu$ V
Electrocardiogram (ECG)	0.05 – 100Hz	1 – 10 mV

In the investigation we focus on the acquisition of EMG signals, generated from the biceps brachial muscle.

### 2.2. Biceps brachial muscle

Its origin and insertion acts on both the shoulder and elbow joints, so this muscle participates in the more than few arm movements. Its name derives from its two heads that join the coracoid process and the supraglenoid tubercle of the scapula. So basically, the biceps muscle has a double origin, but a unique insertion. This defines the structure of the muscle so that it has the two heads that merge into a single distal body. [14]

**Figure 2.** Brachial biceps muscle [23].



In the acquisition of the signal in the muscle, surface electrodes were used and for placement according to the SENIAM standard (Surface ElectroMyoGraphy for the Non-Invasive Assessment of Muscles) [15]. In which it indicates the distance where the electrodes should be placed in the muscle.

### 2.3. Robot-Vehicle prototype findings

#### 2.3.1. Acquisition of the EMG Signal

After determining the theory of EMG signals and identifying which muscle group you want to measure, follow the recommendations of the SENIAM, clean the skin thoroughly, an electrode is placed on the skin, over half the length of the muscle of the Biceps, we will call this mid muscle electrode. Next, a second electrode is placed at one end of the muscle, and we will call it the end muscle electrode. Finally, the third electrode is placed in a bony part of the body near the muscle group, it will be called a reference electrode. [16].

**Figure 3.** Position of the electrodes in the reception of the EMG signal.

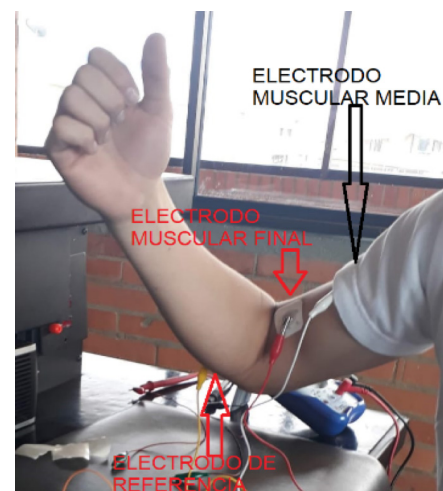

Source: own.

2.4. Development of the EMG signal sensor circuit

The sensor circuit is developed in three parts. They are developed, the first amplification, second rectification and finally the filtering of the signal.

2.5. Amplifier stage

After the reception of the signal, the circuit that amplifies the signal is performed, using the integrated INA106, it is a differential operational amplifier whose function is to measure input that is of small levels (1 - 10  $\mu$ V) and amplify the signal 110 times.

Figure 4. Amplifier stage circuit. [20]

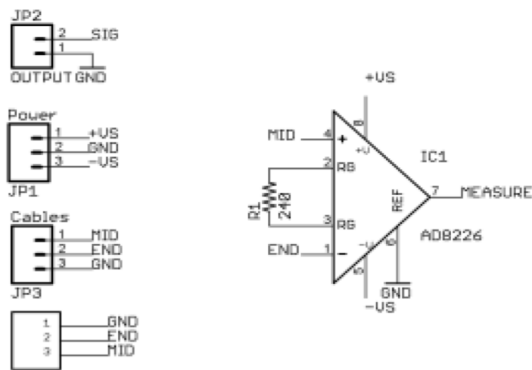

2.5.1. Signal rectification and filtering stage

At this stage we use three TL072 operational amplifiers.

It is a double low noise operational amplifier, ideal in audio circuits, 3 MHz bandwidth, high speed, JFET high impedance inputs, low power consumption. [17]

The circuit performs the rectification of the signal that leaves the amplified INA106, the circuit will carry the negative part of the signal and make it positive, this to position the entire signal in the positive region.

Figure 5. It indicates the input signal in the rectifier circuit and the signal at the output of the rectifier circuit. [21].

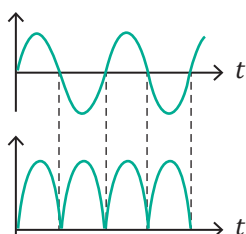

Subsequently, the signal enters the low pass filter, with the purpose of taking the alternating current (AC) signal, converting it to a direct current (DC) voltage, and redirecting to the Arduino card.

Figure 6. It indicates the input signal in the low pass filter circuit and the signal at the output of the low pass circuit. [21]

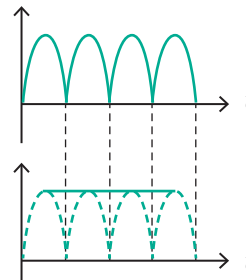
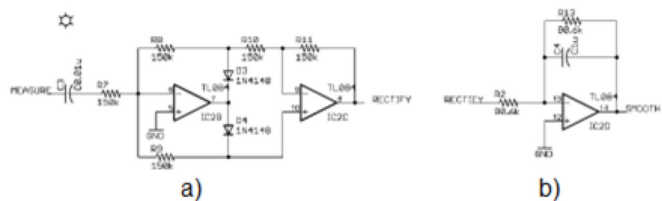

Figure 7. a) Grinding stage and b) signal filtering. [20]



2.5.2. Gain Stage

This is the last stage of the signal sensor another TL072 operational amplifier is used. We take the signal that leaves the active low pass filter, it is acquired at the input of the amplifier circuit and at the output of the amplifier an amplified signal is obtained and with a smoothing to later process it in the Arduino and transmit it wirelessly to the robot car.

Figure 8. Signal gain circuit. [20]

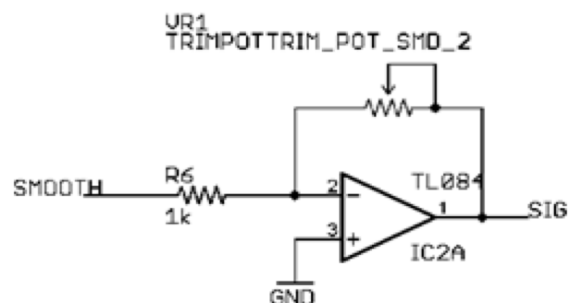

2.6. Signal processing and transmission.

With the operation of the EMG signal sensor, with the amplified signal between the levels of 1.5V to 5.0V, we import it to the Arduino UNO card through the internal analogue converter port (ADC), that the card brings.

**Figure 9.** The pin diagram of the Arduino one is shown. [17]

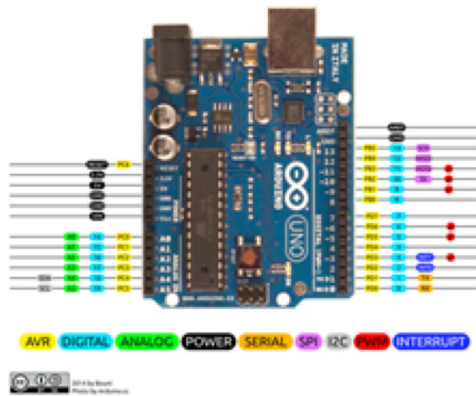

Internally in the Arduino the output of the already digitized signal is generated and with the software the information obtained is processed and assigned to a variable, (remember that the EMG signal is in a range of 1.5V to 5V) [24]. The variable is made equal to the signal and is sent wirelessly via the NRF24L01 antenna. This device is an antenna that transmits at a frequency of 2.4 GHz, and up to 1000 meters.

**Figure 10.** The pin diagram of the NRF24L01 Antenna is shown. [18]

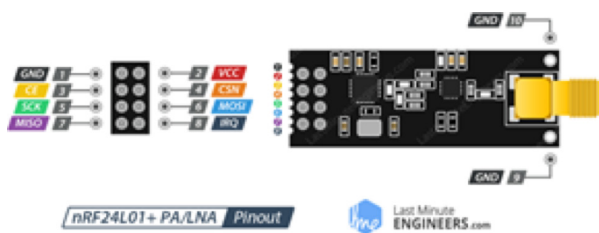

This antenna comes with an SMA connector and a duck antenna, it also brings a special RFX2401C chip that integrates the PA-LNA switching and transmission-reception circuits. This range extender chip along with a duck antenna helps the module achieve a significantly greater transmission range of approximately 1000 meters. [18]

The image shows the acquisition of the EMG signal from the arm and is integrated into the Arduino UNO and then transmitted.

**Figure 11.** EMG signal transmission mode.

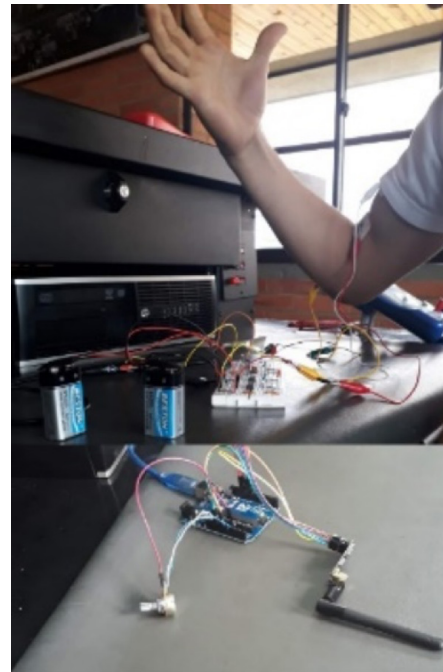

Source: own.

2.7. Receiving, processing, and extracting the signal

The reception of the signal in the robot vehicle is done through the NRF24L01 antenna, which is connected to the other Arduino UNO card located in the robot car. When the variable transmitted by the transmitter is acquired, it is processed by the software and depending on the voltage the program encodes it and assigns it a value that is between 0 to 255, which are the PWM values and control the motors speed.

**Table 2.** Assignment of the variable with respect to the PWM values, which controls the speed of the motors.

VARIABLE (V)	PWM
1,3V	51
2,3V	102
3,3V	153
4,3V	204
5,0V	255

Source: own.

Assigned the value to the PWM, it is distributed through the output port where the driver card that controls the four motors of the robot vehicle is located. Depending on the value of the variable, the motors advance. As the received variable increases or decreases the speed of the robot vehicle's motors will rotate slowly or rapidly.

**Figure 12.** Software responsible for prototype control.

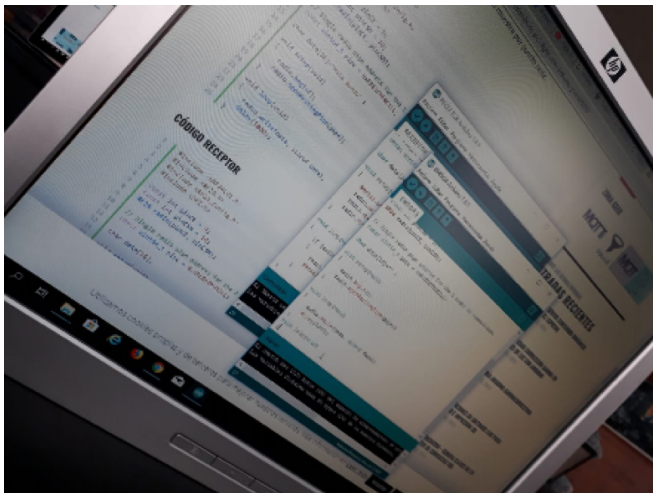

Source: own.

2.8. Vehicle Control-Robot

The control of the vehicle-robot begins at the reception of the variable with the NRF24L01 antenna. The motors are controlled with the Motor Shield V1.0 driver card.

**Figure 13.** The pin diagram of the Shield card is shown. [22]

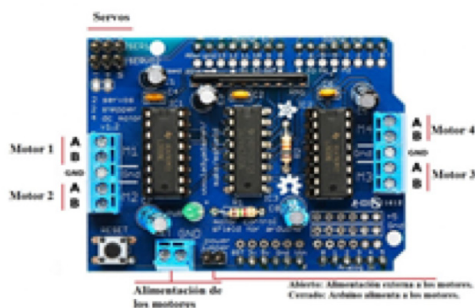

This card is responsible for sending the voltage to each of the motors, depending on the PWM output of the Arduino card where it is connected.

**Figure 14.** Car-robot control system.

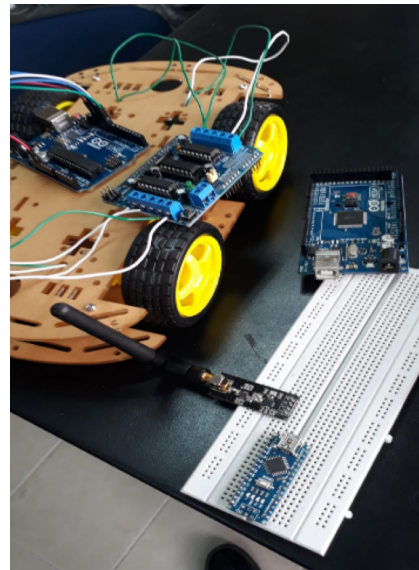

Source: own.

2.9. Analysis of the prototype vehicle-robot tests

The EMG signal tests, driver and motor calibration were performed, along with the variable transmission tests.

2.10.EMG signal settings

In the analysis of the tests of the signal sensor, the variation of the voltages within a range of 1.3 to 5 volts was observed, which were calibrated with the last amplifier stage of the signal sensor and observed in the digital oscilloscope of the laboratory, and thus establish the levels of the signal to be transmitted [23-25].

**Figure 15.** Oscilloscope where adjustments were made to EMG signal levels.



Source: own.

### 2.11. Driver and motor calibration.

In the avionics laboratory, adjustments and calibration of the engines were carried out together with the driver card that oversees the PWM control.

**Figure 16.** Adjustments and calibration of the robot vehicle.

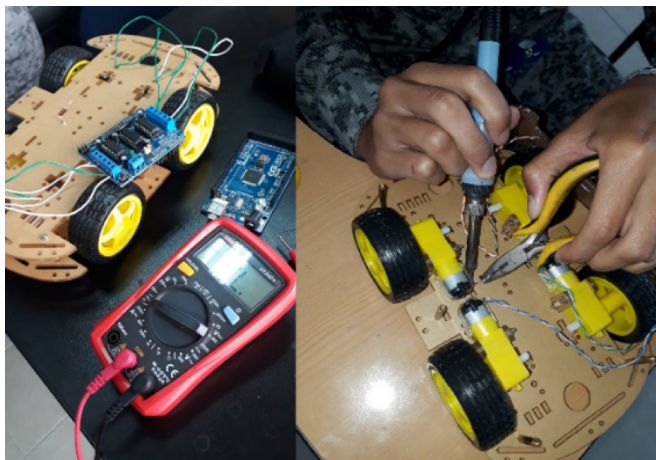

Source: own.

### 2.12. EMG signal transmission assays.

After establishing that the system is calibrated, the EMG signal transmission tests are carried out, it is the one that was observed at different distances, the speed was maintained and when force was exerted on the muscle, the motor-robot engines were accelerated [26-29].

## 3. Conclusions

With the development of the vehicle - Robot project, a new vision is opened to continue investigating EMG signals and implementing them in other possible solutions.

With the application of EMG signals we open other fields in the aeronautical part, to be exploited in the use of these signals. To acquire very small signals of the movements in the muscles, to be able to amplify them, process them and then transmit them wirelessly. This shows us that we can control more complex robotic systems by simply moving one limb of the body.

With this research, the academic community of the noncommissioned officer school of the Colombian Air Force was encouraged. In the study, development, and innovation, in new technologies that use EMG signals.

## References

- [1] P. Konrad, "The ABC of EMG, A Practical introduction to kinesiological Electromyography", NORAXON INC. USA, 2005.
- [2] A. Falcon, A. Taboada, Alberto, R. Llanes, "Selección de Amplificadores de Instrumentación para Acondicionar Señales Bioeléctricas", 2006.
- [3] M. Lucas, A. Gaufriau, S. Pascual, C. Doncarli, D. Farina, "Multi-channel surface EMG classification using support vector machines and signal-based wavelet optimization", *Biomedical Signal Processing and Control*, vol. 3, no. 2, 2008. <https://doi.org/10.1016/j.bspc.2007.09.002>
- [4] J. A. García Pinzón, L. E. Mendoza, "Adquisición Y Procesamiento De Señales Emg Para Controlar Movimiento De Un Brazo Hidráulico", p. 2, 2014.
- [5] H. Kang, K. Rhee, K. You, H. Shin, "Intuitive robot navigation using wireless EMG and acceleration sensors on human arm," *Intelligent Signal Processing and Communications Systems (ISPACS)*, International Symposium, 2011. <https://doi.org/10.1109/ISPACS.2011.6146142>
- [6] E. Butariu, S. Butariu, A. Minodora, L. Novenau, G. Mihalas, "Use of EMG Biofeedback as a Method of muscular training during physical exercise in elders", University of Medicine and Pharmacy Victor Babes, 2009.
- [7] T. Tsushima, "La aplicación clínica de la biorretroalimentación EMG para los dolores de cabeza traumáticos", *Revista Latinoamericana de Psicología*, vol.15, pp. 133-137, 1983.
- [8] A. Romo, C. Realpe, E. Jojoa, "Análisis de Señales EMG Superficiales y su Aplicación en Control de Prótesis de Mano", Universidad del Cauca, 2007.
- [9] C. Castellini, P. Smagt, "Surface EMG in advanced hand prosthetics", Springer-Verlag 2008. <https://doi.org/10.1007/s00422-008-0278-1>
- [10] A. Ferreira, W. Celeste, F. Cheein, T. Bastos-Filho, M. Sarcinelli-Filho, "Human-machine interfaces based on EMG and EEG applied to robotic systems", *Journal of NeuroEngineering and Rehabilitation*, 2008. <https://doi.org/10.1186/1743-0003-5-10>

- [11] J. Gómez-Gil, I. González, L. F. Alonso, S. Garcia, “Steering a Tractor by Means of an EMG-Based Human- Machine Interface”, Department of Signal Theory, Communications and Telematics Engineering, University of Valladolid, 2011. <https://doi.org/10.3390/s110707110>
- [12] I. Cifuentes González, “Extracción de Características y Clasificación de Señales Electromiográficas Utilizando la Transformada Hilbert-Huang y Redes Neuronales”, Instituto Nacional de Astrofísica, Óptica y Electrónica, (INAOE), México, 2012.
- [13] C. A. Riaño Ríos, V. E. Quintero Machado, “Control de una mano virtual usando señales electromiográficas”, tesis, Departamento de Ingeniería en Mecatrónica, Universidad UMNG, Bogotá, Colombia, 2010.
- [14] C. Beltre, “Músculo bíceps braquial”, 2019. [Online]. Available at: <https://www.anatomiatopografica.com/musculos/musculo-biceps-braquial/>.
- [15] H. J. Hermens, B. Freriks, “SENIAM”, 2006. [Online]. Available at: <http://www.seniam.org/>
- [16] D. M. Moreno, “¿cómo hacer su propio circuito sensor de músculo / EMG?”, 2016. [Online]. Available at: <https://emgprotesisdmm.wordpress.com/>.
- [17] Electrónicos Caldas, “Tienda virtual de componentes electrónicos”, Colombia, 2019. [Online]. Available at: <https://www.electronicoscaldas.com/es/amplificadores-operacionales/424-amplificador-operacional-tlo72.html>
- [18] Patagoniatec, “NRF24L01 + RFX2401”, Argentina, 2014. [Online]. Available at: <https://saber.patagoniatec.com/2014/07/nrf24l01-rfx2401-nrf24l01-pa-lna-arduino-argentina-ptec/>.
- [19] R. Merletti, “Electromyography - Physiology, Engineering, and Noninvasive Applications”, IEEE Press Engineering in Medicine and Biology Society, 2004. <https://doi.org/10.1002/0471678384>
- [20] B. Kaminski, “Muscle sensor V3”, 2014. [Online]. Available at: <http://www.advancertechnologies.com/p/muscle-sensor-v3.html>.
- [21] Emgprotesisdmm, “¿cómo hacer su propio circuito sensor de músculo / EMG?”, 2016. [Online]. Available at: <https://emgprotesisdmm.wordpress.com/2016/08/02/como-hacer-su-propio-circuito-sensor-de-musculo-emg/>
- [22] Robots Didácticos, “Manejo de potencia para motores con el integrado L293D”, 2018. [Online]. Available at: <http://robots-argentina.com.ar/didactica/manejo-de-potencia-para-motores-con-el-integrado-l293d/>.
- [23] J. L. Correa-Figueroa, E. Morales-Sánchez, J. A. Huerta-Ruelas, J. J. González-Barbosa, “Sistema de Adquisición de Señales SEMG para la Detección de Fatiga Muscular”, *Revista Mexicana de Ingeniería Biomédica*, vol. 37, no. 1, 2016.
- [24] A. F. Barbosa Franco, L. A. Noguera Vega, W. M. Giral Ramírez, “Análisis de distorsión armónica en iluminación LED”, *Revista Vínculos*, vol. 14, no. 2, pp. 95–107, 2017. <https://doi.org/10.14483/2322939X.12520>
- [25] C. Cavadía, F. Payares, K. Herrera, J. Jaramillo, L. Meza, “Los entornos virtuales de aprendizaje como estrategia de mediación pedagógica”, *Aglala*, vol. 10, no. 2, pp. 212-22, 2019
- [26] H. Ortega Neri, E. Pérez Márquez, J. Acosta, “Competencias del docente, un estudio en la Universidad Autónoma de Zacatecas, México”, *Conocimiento Global*, vol. 5, no. 2, pp. 1-15, 2020.
- [27] W. Martínez Amado, L. M. Barbosa Guerrero, I. F. Amaya Cocunubo, H. Guzmán Ramos, “¿Son los momentos de crisis, una oportunidad para las marcas?”, *Enfoque Disciplinario*, vol. 5, no. 2, pp. 19-23, 2020.
- [28] O. Vásquez Duarte, D. García Muñoz, J. Páez Páez, “Conquistando Soacha - Herramientas pedagógicas para intervención de dificultades relacionadas con los dispositivos básicos de aprendizaje”, *Conocimiento Global*, vol. 4, no. 1, pp. 12-25, 2019.
- [29] J. P. Ortiz Quevedo, R. Nuñez Uribe, “Percepciones docentes de las didácticas en el entorno virtual”, *Conocimiento Global*, vol. 4, no. 1, pp. 67-78, 2019.